

2019-2020

# Notice de montage Local Technique 1.45x1.25

# OZEOBOIS

Designer de piscine bois



PISCINES CONCEPT BOIS IRC Toulouse 523 673 184



**GAMME DES COULEURS DISPONIBLES**

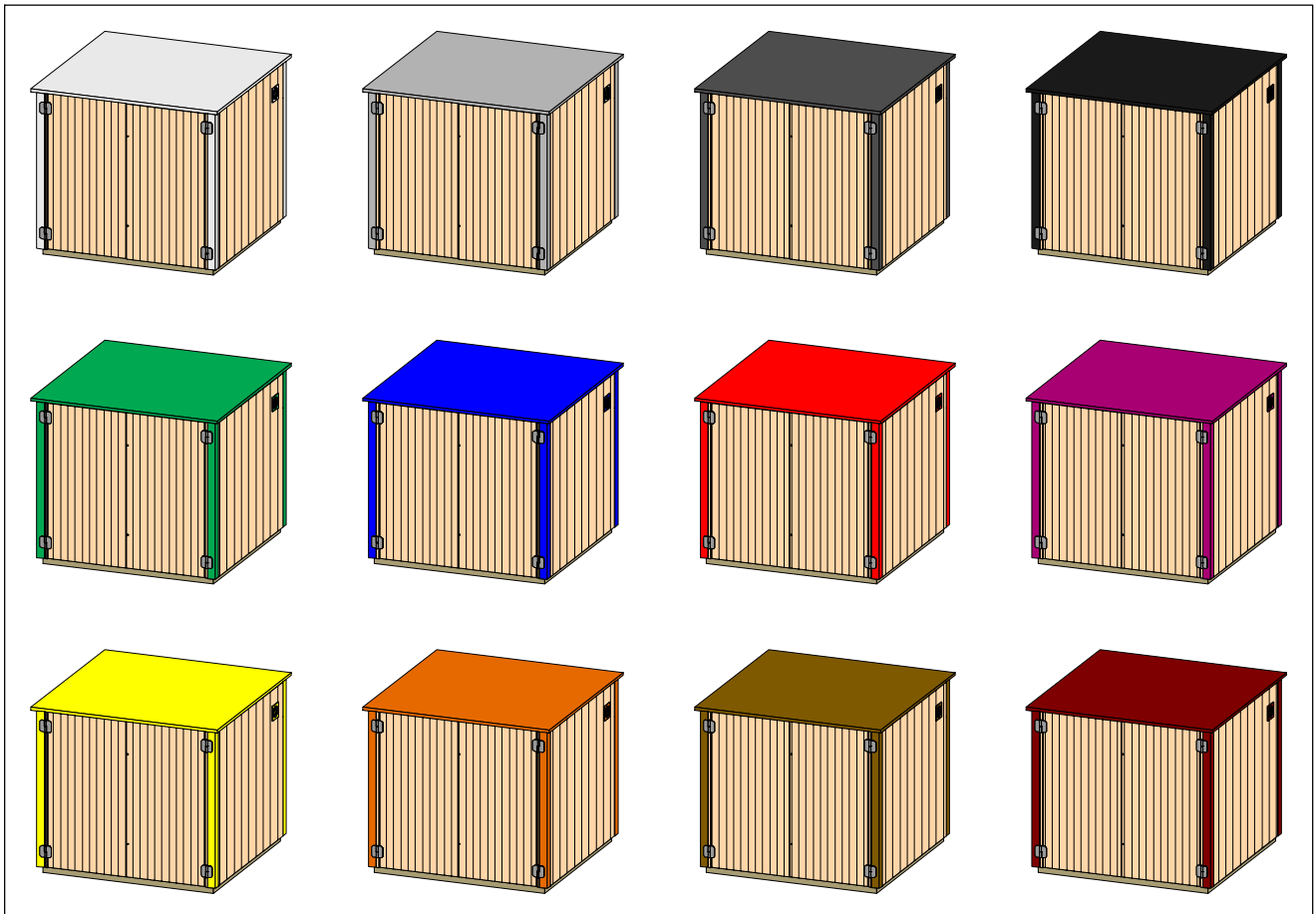

# NOMENCLATURE DES ELEMENTS CONSTITUANTS LE KIT

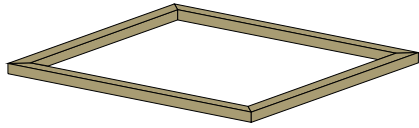

Cadre d'implantation

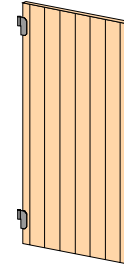

Porte gauche

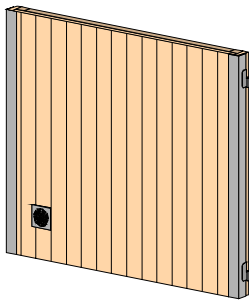

Côté gauche

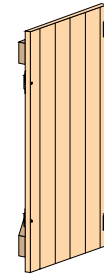

Porte droite

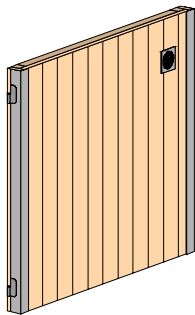

Côte droit

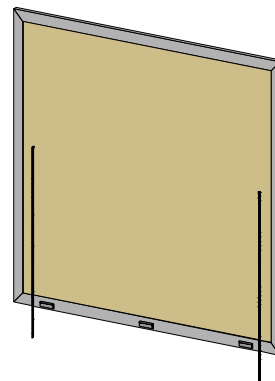

Toit

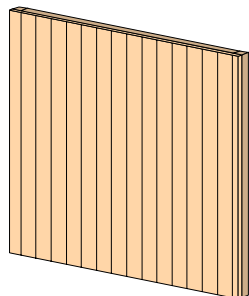

Fond



Clé



Vis 5x90 (x 8)



Vis 5x70 (x 14)



Vis 5x50 (x 9)



Vis 6x40 (x 2)

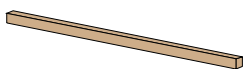

Traverse (x 2)



Contrefiche (x 2)

Embout Vis T25

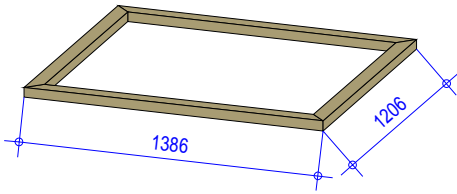

1 - Fixer le cadre d'implantation sur un sol plat

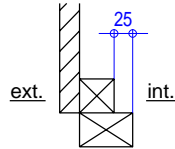
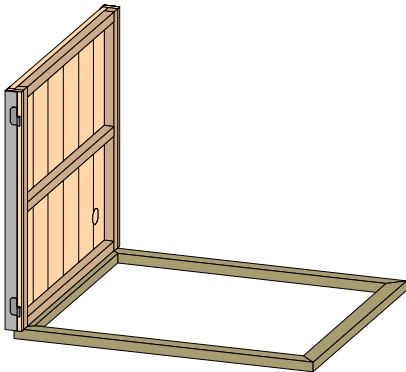

2 - Présenter le côté gauche sur le cadre d'implantation en laissant 25mm côté intérieur

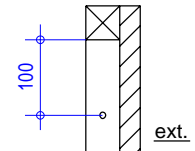
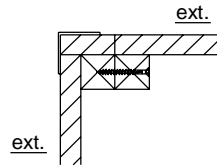
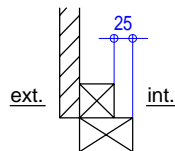
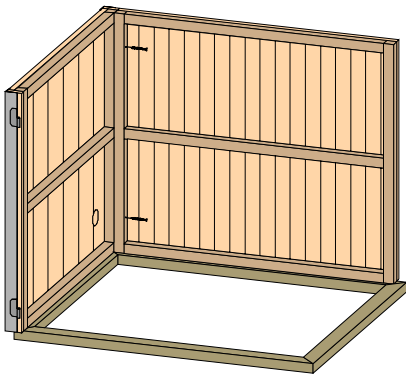

3 - Présenter le fond contre le côté gauche et sur le cadre d'implantation en laissant 25mm côté intérieur

4 - Lier le fond au côté gauche (2 vis 5x70)

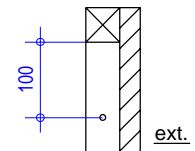
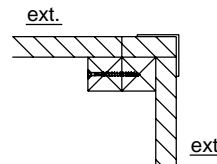
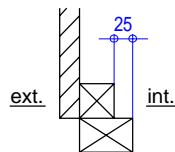
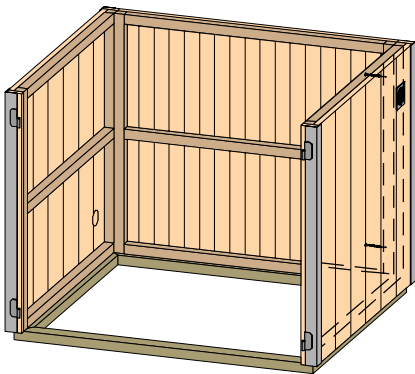

5 - Présenter le côté droit contre le fond et sur le cadre d'implantation en laissant 25mm côté intérieur

6 - Lier le fond au côté droit (2 vis 5x70)

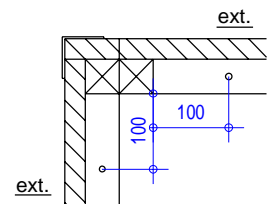
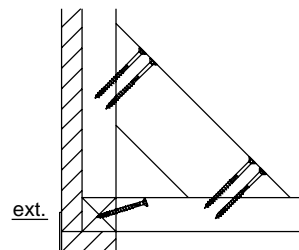
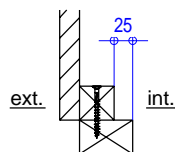
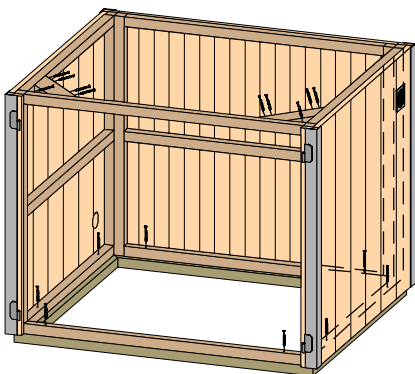

7 - Fixer la traverse haute en façade entre les deux côtés (2 vis 5x70)

8 - Fixer les deux contrefiches reliant les côtés à la traverse haute (2 x 4 vis 5x90)

9 - Fixer la structure et la traverse basse en façade sur le cadre d'implantation (4 x 2 vis 5x70)

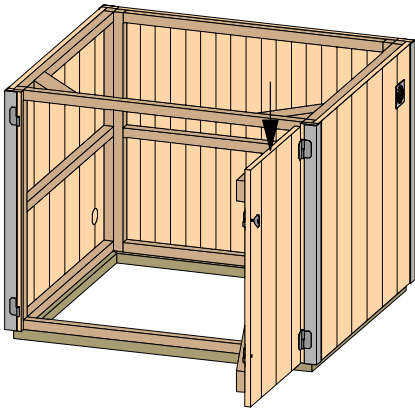

10 - Positionner la porte droite avec les deux paumelles

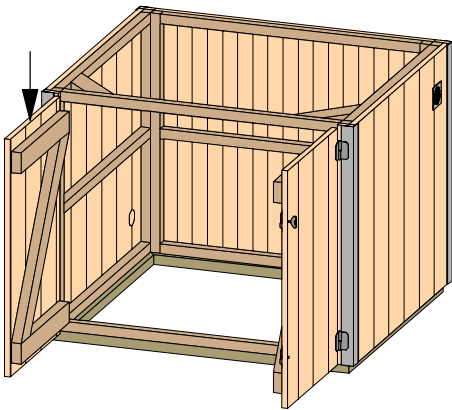

11 - Positionner la porte gauche avec les deux paumelles

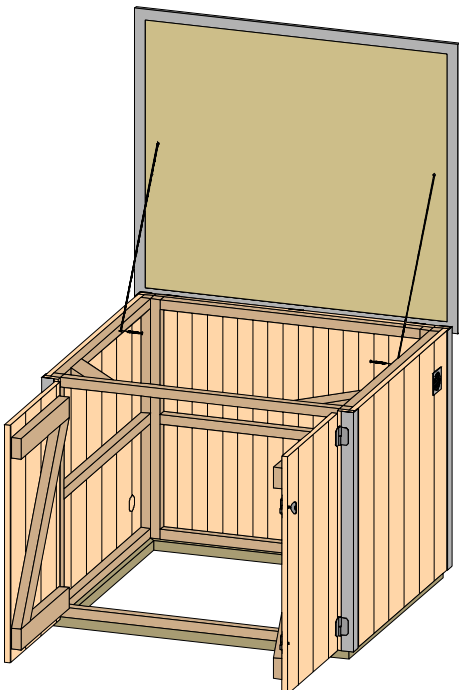

12 - Fixer le toit sur le fond avec les trois charnières (3 x 3 vis 5x50)

13 - Accrocher les chaînettes sur les deux côtés (2 vis 6x40)

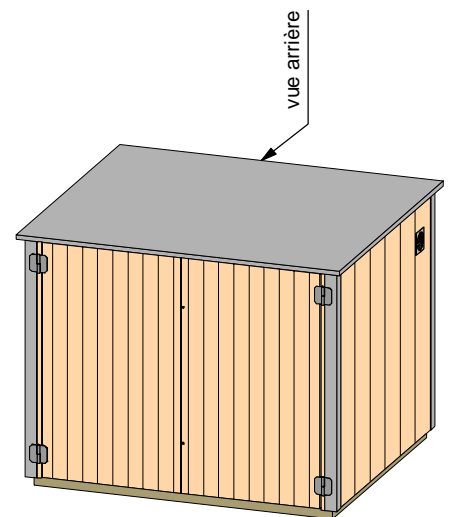
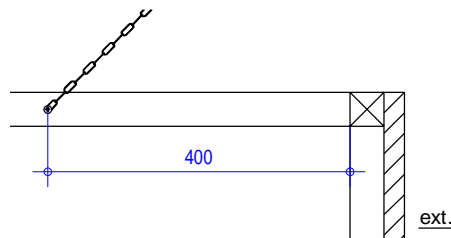
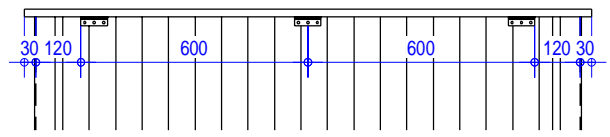
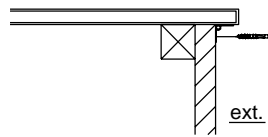

# DECOUVREZ EGALEMENT NOTRE GAMME DE JARDINIÈRES

